

Data sheet | Item number: 750-362
 Fieldbus Coupler Modbus TCP; 4th generation

www.wago.com/750-362

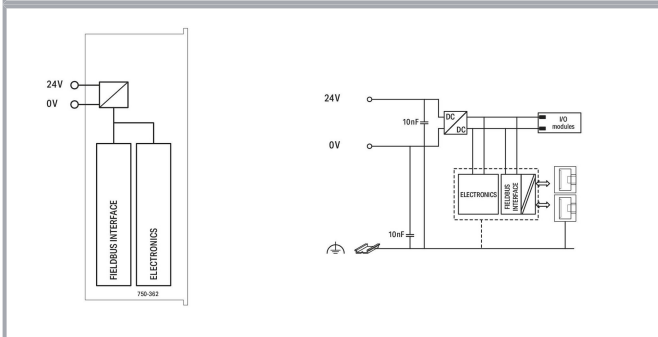
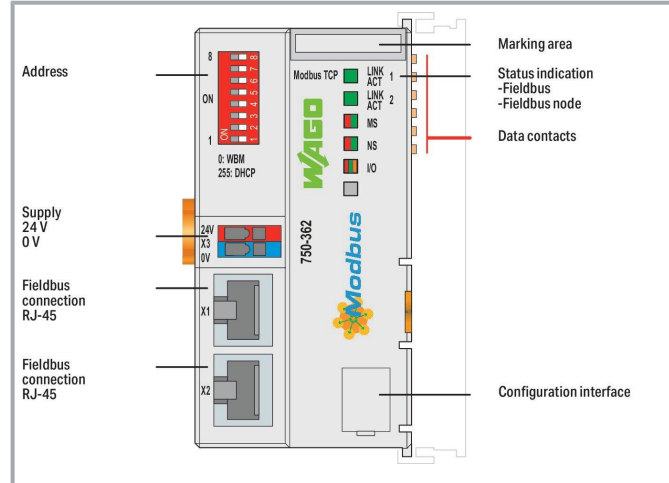

Item description

The 750-362 Modbus TCP/UDP Fieldbus Coupler connects ETHERNET to the modular WAGO I/O System.

Subject to changes. Please also observe the further product documentation!

WAGO GmbH & Co. KG
 Hansastr. 27
 32423 Minden
 Phone: +49571 887-0 | Fax: +49571 887-169
 Email: info.de@wago.com | Web: www.wago.com

Do you have any questions about our products?
 We are always happy to take your call at +49 (571) 887-44222.



The fieldbus coupler detects all connected I/O modules and creates a local process image.

Two ETHERNET interfaces and an integrated switch allow the fieldbus to be wired in a line topology, eliminating the need for additional network devices, such as switches or hubs.

Both interfaces support autonegotiation and Auto-MDI(X).

The DIP switch configures the last byte of the IP address and may be used for IP address assignment (DHCP, BootP, static).

The coupler is designed for fieldbus communication in MODBUS networks.

It also supports a wide variety of standard ETHERNET protocols (e.g., HTTP(S), BootP, DHCP, DNS, SNMP, (S)FTP). An integrated Webserver provides user configuration options, while displaying the coupler's status information.

The system supply is provided directly by the coupler. The field supply is provided via a separate supply module.

Data

Technical data

Communication	Modbus (TCP, UDP)
ETHERNET protocols	HTTP(S) BootP DHCP DNS SNTP FTP(S) SNMP
Baud rate	10/100 Mbit/s
Transmission medium	Twisted Pair S-UTP; 100 Ω; Cat. 5; 100 m maximum cable length
Transmission performance	Class D per EN 50173
Number of modules per node (max.)	250
Number of modules without a bus extension (max.)	64
Input and output process image (fieldbus) max.	1020 words/1020 words
Supply voltage (system)	24 VDC (-25 ... +30 %); via pluggable connector
Current consumption (5 V system supply)	350 mA
Total current (system supply)	700 mA
Input current (typ.) at nominal load (24 V)	280 mA
Power supply efficiency (typ.) at nominal load (24 V)	90 %
Isolation	500 V system/field
Indicators	LED (LINK/ACT) green: Network connection via ports 1 ... 2; LED (MS, NS) red/green: Status of node, network; LED (I/O) red/green

Subject to changes. Please also observe the further product documentation!

/orange: Status of local data bus

Connection data

Connection technology: communication/fieldbus	Modbus (TCP, UDP): 2 x RJ-45
Connection technology: system supply	2 x CAGE CLAMP®
Connection technology: device configuration	1 x Male connector; 4-pole
Connection type 1	System supply
Solid conductor	0.08 ... 2.5 mm ² / 28 ... 14 AWG
Fine-stranded conductor	0.08 ... 2.5 mm ² / 28 ... 14 AWG
Strip length	8 ... 9 mm / 0.31 ... 0.35 inches

Physical data

Width	49.5 mm / 1.949 inches
Height	96.8 mm / 3.811 inches
Depth	71.9 mm / 2.831 inches
Depth from upper-edge of DIN-rail	64.7 mm / 2.547 inches

Mechanical Data

Mounting type	DIN-35 rail
---------------	-------------

Material Data

Housing material	Polycarbonate; polyamide 6.6
Fire load	1.394 MJ
Weight	104.8 g
Conformity marking	CE

Environmental requirements

Ambient temperature (operation)	0 ... +55 °C
Surrounding air temperature (storage)	-25 ... +85 °C
Protection type	IP20
Pollution degree (5)	2 per IEC 61131-2
Operating altitude	0 ... 2000 m / 0 ... 6562 ft
Mounting position	horizontal (standing/lying); vertical
Relative humidity (without condensation)	95 %
Vibration resistance	4g per IEC 60068-2-6
Shock resistance	15g per IEC 60068-2-27

Subject to changes. Please also observe the further product documentation!



EMC immunity to interference	per EN 61000-6-2, marine applications
EMC emission of interference	per EN 61000-6-3, marine applications
Exposure to pollutants	Per IEC 60068-2-42 and IEC 60068-2-43
Permissible H ₂ S contaminant concentration at a relative humidity 75 %	10 ppm
Permissible SO ₂ contaminant concentration at a relative humidity 75 %	25 ppm

Commercial data

eCl@ss 10.0	27-24-26-07
eCl@ss 9.0	27-24-26-07
ETIM 8.0	EC001603
ETIM 7.0	EC001603
PU (SPU)	1 pcs
Packaging type	box
Country of origin	DE
GTIN	4055143821421
Customs tariff number	85176200000

Approvals / Certificates

General approvals

Logo	Approval	Additional Approval Text	Certificate name
	EAC Brjansker Zertifizierungsstelle	TP TC 020/2011	EAC RU C-DE.AM02.B.00087/19
	KC National Radio Research Agency	Article 58-2, Clause 3	MSIP-REM-W43-FBC750
	UL Underwriters Laboratories Inc. (ORDINARY LOCATIONS)	UL 61010-2-201	E175199 Sec11

Approvals for marine applications

Logo	Approval	Additional Approval Text	Certificate name
	ABS American Bureau of Shipping	-	22-2219060

Subject to changes. Please also observe the further product documentation!



	BSH Bundesamt fuer Seeschifffahrt und Hydrographie	-	1104
---	--	---	------



	BV Bureau Veritas S.A.	Rules for class. of Steel Ships	66711/A0
---	----------------------------------	---------------------------------	----------



	DNV DNV Germany GmbH	DNV-CG-0339, Aug. 2021	TAA0000194
--	--------------------------------	------------------------	------------



	KR Korean Register of Shipping	-	KR HMB05880-AC001
--	--	---	-------------------



	LR Lloyds Register EMEA	-	LR22180952TA
--	-----------------------------------	---	--------------





	PRS Polski Rejestr Statków	-	TE/2236/880590/19
---	--------------------------------------	---	-------------------

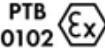

	RINA RINA Germany GmbH	-	ELE343521XG001
--	----------------------------------	---	----------------

Approvals for hazardous areas

Logo	Approval	Additional Approval Text	Certificate name
	ATEX TUEV Nord Cert GmbH	EN 60079-0	TUEV_14_ATEX_148929_X (II 3 G Ex ec IIC T4 Gc)
	CCC CNEX	CNCA-C23-01	2020312310000213 (Ex ec IIC T4 Gc)
	EAC	TP TC 012/2011	EAC RU C-DE.AM02.B.00163

Subject to changes. Please also observe the further product documentation!

Brjansker Zertifizierungsstelle

/19 (2Ex e IIC T4 Gc X)



	IECEX TUEV Nord Cert GmbH	IEC 60079-0	IECEX_TUN_14.0035_X (Ex ec IIC T4 Gc)
	INMETRO TÜV Rheinland do Brasil Ltda.	IEC 60079-0	BR-Ex_TÜV 12.1297 X
	KTL Korea Testing Laboratory	KOSHA Article 34, IEC60079-0	20-KA4BO-0109X
	UKEx WAGO GmbH & Co. KG	EN 60079-0	UKCA_WAGO22UKEX003X_ec
	UL Underwriters Laboratories Inc. (HAZARDOUS LOCATIONS)	UL 121201	E198726 Sec.1



Optional accessories

Communication

Bluetooth

	Item no.: 750-921 Bluetooth® Adapter	www.wago.com/750-921
--	--	--

Communication cable

	Item no.: 750-923 Configuration cable; USB connector; Length: 2.5 m	www.wago.com/750-923
	Item no.: 750-923/000-001 Configuration cable; USB connector; Length: 5 m	www.wago.com/750-923/000-001

Shield termination







Shield clamping saddles

	Item no.: 790-116 Shield clamping saddle; 19 mm wide; diameter of compatible conductor; 7 ... 16 mm	www.wago.com/790-116
--	---	--









Subject to changes. Please also observe the further product documentation!

WAGO GmbH & Co. KG
 Hansastr. 27
 32423 Minden
 Phone: +49571 887-0 | Fax: +49571 887-169
 Email: info.de@wago.com | Web: www.wago.com

Do you have any questions about our products?
 We are always happy to take your call at +49 (571) 887-44222.

	Item no.: 790-124 Shield clamping saddle; 27 mm wide; diameter of compatible conductor; 6 ... 24 mm	www.wago.com/790-124
	Item no.: 790-108 Shield clamping saddle; 11 mm wide; diameter of compatible conductor; 3 ... 8 mm	www.wago.com/790-108
	Item no.: 790-140 Shield clamping saddle; diameter of compatible conductor	www.wago.com/790-140
	Item no.: 790-216 Shield clamping saddle; 21.8 mm wide; 6 ... 16 mm	www.wago.com/790-216
	Item no.: 790-220 Shield clamping saddle; 30 mm wide; 6 ... 20 mm	www.wago.com/790-220
	Item no.: 790-208 Shield clamping saddle; 12.4 mm wide; 3 ... 8 mm	www.wago.com/790-208

System housing

System enclosure		
	Item no.: 850-814/002-000 IP65 enclosure; Sheet steel (RAL 7035); WxHxD (200x120x200 mm); without flange plate	www.wago.com/850-814/002-000
	Item no.: 850-815/002-000 IP65 enclosure; Sheet steel (RAL 7035); WxHxD (300x120x200 mm); without flange plate	www.wago.com/850-815/002-000
	Item no.: 850-816/002-000 IP65 enclosure; Sheet steel (RAL 7035); WxHxD (400x120x200 mm); without flange plate	www.wago.com/850-816/002-000
	Item no.: 850-817/002-000 IP65 enclosure; Sheet steel (RAL 7035); WxHxD (600x120x200 mm); without flange plate	www.wago.com/850-817/002-000
	Item no.: 850-825 IP65 enclosure; Aluminium (RAL 7032); WxHxD (160x100x160 mm); 9 x M12, 4 x M20	www.wago.com/850-825
	Item no.: 850-826 IP65 enclosure; Aluminium (RAL 7032); WxHxD (240x100x160 mm); 4 x M20, 4 x M16, 14 x M12 cable grip	www.wago.com/850-826
	Item no.: 850-827 IP65 enclosure; Aluminium (RAL 7032); WxHxD (320x100x160 mm); 4 x M20, 8 x M16, 17 x M12 cable grip	www.wago.com/850-827
	Item no.: 850-827/002-000 IP65 enclosure; Aluminium (RAL 7035); WxHxD (320x100x160 mm); 4 x M20, 8 x M16, 17 x M12 cable grip	www.wago.com/850-827/002-000
	Item no.: 850-826/002-000 IP65 enclosure; Aluminium (RAL 7035); WxHxD (240x100x160 mm); 4 x M20, 4 x M16, 14 x M12 cable grip	www.wago.com/850-826/002-000

Subject to changes. Please also observe the further product documentation!



Item no.: 850-828/002-000

IP65 enclosure; Aluminium (RAL 7035); WxHxD (480x100x160 mm); 4 x M20, 10 x M16, 35 x M12 cable grip

www.wago.com/850-828/002-000



Item no.: 850-828

IP65 enclosure; Aluminium (RAL 7032); WxHxD (480x100x160 mm); 4 x M20, 10 x M16, 35 x M12 cable grip

www.wago.com/850-828



Item no.: 850-834

IP65 enclosure; Polyester (RAL 7032); WxHxD (164x100x164 mm); 9 x M12, 4 x M20

www.wago.com/850-834



Item no.: 850-835

IP65 enclosure; Polyester (RAL 7032); WxHxD (244x100x164 mm); 4 x M20, 4 x M16, 14 x M12 cable grip

www.wago.com/850-835



Item no.: 850-836

IP65 enclosure; Polyester (RAL 7032); WxHxD (324x100x164 mm); 4 x M20, 8 x M16, 17 x M12 cable grip

www.wago.com/850-836

Carrier rail

Mounting accessories



Item no.: 210-197

Steel carrier rail; 35 x 15 mm; 1.5 mm thick; 2 m long; slotted; similar to EN 60715; silver-colored

www.wago.com/210-197



Item no.: 210-198

Copper carrier rail; 35 x 15 mm; 2.3 mm thick; 2 m long; unslotted; according to EN 60715; copper-colored

www.wago.com/210-198



Item no.: 210-504

Steel carrier rail; 35 x 7.5 mm; 1 mm thick; 2 m long; slotted; galvanized; according to EN 60715; silver-colored

www.wago.com/210-504



Item no.: 210-505

Steel carrier rail; 35 x 7.5 mm; 1 mm thick; 2 m long; unslotted; galvanized; according to EN 60715; silver-colored

www.wago.com/210-505



Item no.: 210-506

Steel carrier rail; 35 x 15 mm; 1.5 mm thick; 2 m long; unslotted; galvanized; similar to EN 60715; silver-colored

www.wago.com/210-506



Item no.: 210-508

Steel carrier rail; 35 x 15 mm; 1.5 mm thick; 2 m long; slotted; galvanized; similar to EN 60715; silver-colored

www.wago.com/210-508

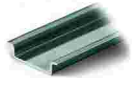

Item no.: 210-113

Steel carrier rail; 35 x 7.5 mm; 1 mm thick; 2 m long; unslotted; according to EN 60715; silver-colored

www.wago.com/210-113



Item no.: 210-118

Steel carrier rail; 35 x 15 mm; 2.3 mm thick; 2 m long; unslotted; according to EN 60715; silver-colored

www.wago.com/210-118



Item no.: 210-112

Steel carrier rail; 35 x 7.5 mm; 1 mm thick; 2 m long; slotted; according to EN 60715; "Hole width 25 mm; silver-colored

www.wago.com/210-112

Subject to changes. Please also observe the further product documentation!

WAGO GmbH & Co. KG

Hansastr. 27

32423 Minden

Phone: +49571 887-0 | Fax: +49571 887-169

Email: info.de@wago.com | Web: www.wago.com

Do you have any questions about our products?

We are always happy to take your call at +49 (571) 887-44222.



Item no.: 210-114

Steel carrier rail; 35 x 15 mm; 1.5 mm thick; 2 m long; unslotted; similar to EN 60715; silver-colored

www.wago.com/210-114



Item no.: 210-115

Steel carrier rail; 35 x 7.5 mm; 1 mm thick; 2 m long; slotted; according to EN 60715; "Hole width 18 mm; silver-colored

www.wago.com/210-115



Item no.: 210-196

Aluminum carrier rail; 35 x 8.2 mm; 1.6 mm thick; 2 m long; unslotted; similar to EN 60715; silver-colored

www.wago.com/210-196

Marking accessories

Marker



Item no.: 2009-145/000-006

Mini-WSB Inline; for Smart Printer; 1700 pieces on roll; stretchable 5 - 5.2 mm; plain; snap-on type; blue

www.wago.com/2009-145

[/000-006](http://www.wago.com/2009-145/000-006)



Item no.: 2009-145

Mini-WSB Inline; for Smart Printer; 1700 pieces on roll; stretchable 5 - 5.2 mm; plain; snap-on type; white

www.wago.com/2009-145



Item no.: 2009-145/000-002

Mini-WSB Inline; for Smart Printer; 1700 pieces on roll; stretchable 5 - 5.2 mm; plain; snap-on type; yellow

www.wago.com/2009-145

[/000-002](http://www.wago.com/2009-145/000-002)



Item no.: 2009-145/000-007

Mini-WSB Inline; for Smart Printer; 1700 pieces on roll; stretchable 5 - 5.2 mm; plain; snap-on type; gray

www.wago.com/2009-145

[/000-007](http://www.wago.com/2009-145/000-007)



Item no.: 2009-145/000-005

Mini-WSB Inline; for Smart Printer; 1700 pieces on roll; stretchable 5 - 5.2 mm; plain; snap-on type; red

www.wago.com/2009-145

[/000-005](http://www.wago.com/2009-145/000-005)



Item no.: 2009-145/000-012

Mini-WSB Inline; for Smart Printer; 1700 pieces on roll; stretchable 5 - 5.2 mm; plain; snap-on type; orange

www.wago.com/2009-145

[/000-012](http://www.wago.com/2009-145/000-012)



Item no.: 2009-145/000-023

Mini-WSB Inline; for Smart Printer; 1700 pieces on roll; stretchable 5 - 5.2 mm; plain; snap-on type; green

www.wago.com/2009-145

[/000-023](http://www.wago.com/2009-145/000-023)



Item no.: 2009-145/000-024

Mini-WSB Inline; for Smart Printer; 1700 pieces on roll; stretchable 5 - 5.2 mm; plain; snap-on type; violet

www.wago.com/2009-145

[/000-024](http://www.wago.com/2009-145/000-024)



Item no.: 248-501/000-006

Mini-WSB marking card; as card; not stretchable; plain; snap-on type; blue

www.wago.com/248-501

[/000-006](http://www.wago.com/248-501/000-006)

Subject to changes. Please also observe the further product documentation!

WAGO GmbH & Co. KG

Hansastr. 27

32423 Minden

Phone: +49571 887-0 | Fax: +49571 887-169

Email: info.de@wago.com | Web: www.wago.com

Do you have any questions about our products?

We are always happy to take your call at +49 (571) 887-44222.



Item no.: 248-501/000-007
Mini-WSB marking card; as card; not stretchable; plain; snap-on type; gray

www.wago.com/248-501/000-007



Item no.: 248-501/000-002
Mini-WSB marking card; as card; not stretchable; plain; snap-on type; yellow

www.wago.com/248-501/000-002



Item no.: 248-501/000-012
Mini-WSB marking card; as card; not stretchable; plain; snap-on type; orange

www.wago.com/248-501/000-012



Item no.: 248-501
Mini-WSB marking card; as card; not stretchable; plain; snap-on type; white

www.wago.com/248-501



Item no.: 248-501/000-017
Mini-WSB marking card; as card; not stretchable; plain; snap-on type; light green

www.wago.com/248-501/000-017



Item no.: 248-501/000-005
Mini-WSB marking card; as card; not stretchable; plain; snap-on type; red

www.wago.com/248-501/000-005



Item no.: 248-501/000-024
Mini-WSB marking card; as card; not stretchable; plain; snap-on type; violet

www.wago.com/248-501/000-024



Item no.: 248-501/000-023
Mini-WSB marking card; as card; not stretchable; plain; snap-on type; green

www.wago.com/248-501/000-023

Cables and pluggable connectors

Connector plug



Item no.: 750-975
ETHERNET RJ-45 connector, IP20; ETHERNET 10/100 Mbit/s; for field assembly

www.wago.com/750-975



Item no.: 750-978/000-012
Connector ETHERNET; RJ-45; Cat. 6A; straight; Code T568B; AWG 22; Strain relief

www.wago.com/750-978/000-012



Item no.: 750-979/000-012
Connector ETHERNET; RJ-45; Cat. 6A; angled; Code T568B; AWG 22; Strain relief



www.wago.com/750-979/000-012



Item no.: 750-978/000-021
Connector ETHERNET; RJ-45; Cat. 6A; straight; Code T568A; AWG 24; Strain relief

www.wago.com/750-978/000-021

Subject to changes. Please also observe the further product documentation!

	Item no.: 750-979/000-022 Connector ETHERNET; RJ-45; Cat. 6A; angled; Code T568B; AWG 24; Strain relief	www.wago.com/750-979/000-022
	Item no.: 750-978/000-022 Connector ETHERNET; RJ-45; Cat. 6A; straight; Code T568B; AWG 24; Strain relief	www.wago.com/750-978/000-022
	Item no.: 750-979/000-011 Connector ETHERNET; RJ-45; Cat. 6A; angled; Code T568A; AWG 22; Strain relief	www.wago.com/750-979/000-011
	Item no.: 750-979/000-021 Connector ETHERNET; RJ-45; Cat. 6A; angled; Code T568A; AWG 24; Strain relief	www.wago.com/750-979/000-021
	Item no.: 750-977/000-011 Connector ETHERNET; RJ-45; Cat. 6A; straight; Code T568A; AWG 22	www.wago.com/750-977/000-011
	Item no.: 750-978/000-011 Connector ETHERNET; RJ-45; Cat. 6A; straight; Code T568A; AWG 22; Strain relief	www.wago.com/750-978/000-011
	Item no.: 750-977/000-022 Connector ETHERNET; RJ-45; Cat. 6A; straight; Code T568B; AWG 24	www.wago.com/750-977/000-022
	Item no.: 750-977/000-012 Connector ETHERNET; RJ-45; Cat. 6A; straight; Code T568B; AWG 22	www.wago.com/750-977/000-012
	Item no.: 750-977/000-021 Connector ETHERNET; RJ-45; Cat. 6A; straight; Code T568A; AWG 24	www.wago.com/750-977/000-021

Downloads Documentation

Manual			
System Manual WAGO I/O System 750/753 Decentralized Automation Technology	V 3.1.0 05.12.2022	pdf 8.7 MB	Download
Product Manual Fieldbus Coupler Modbus TCP Generation 4 (BootP)	V 1.1.1 25.05.2022	pdf 4.2 MB	Download
System Manual Series 750/753 Online HTML		URL	Download

Subject to changes. Please also observe the further product documentation!



Bid Text

750-362 docx - Datei	18.06.2019	docx 17.8 kB	Download
750-362 X81 - Datei	19.02.2019	xml 7.0 kB	Download
ausschreiben.de 750-362		URL	Download

Additional Information

Disposal and Recycling	V 1.1.0	pdf	Download
Electrical and electronic equipment, Batteries, Packaging	18.08.2022	2.2 MB	

System Description

750/753 Series I/O-System – General Product Information		pdf 1.7 MB	Download
Overview on WAGO-I/O-SYSTEM 750 approvals		pdf 789.0 kB	Download

Runtime Software

Firmware

0750-036x, Feldbuskoppler	V 10	zip	Download
WAGO_FW0750_036x_V010504_IX10_B	10.02.2022	3.8 MB	

CAD/CAE-Data

CAD data

2D/3D Models 750-362		URL	Download
----------------------	--	-----	----------

CAE data

ZUKEN Portal 750-362		URL	Download
EPLAN Data Portal 750-362		URL	Download

Subject to changes. Please also observe the further product documentation!

Data sheet | Item number: 750-362

www.wago.com/750-362



Environmental Product Compliance

Compliance Search

Environmental Product Compliance 750-362
Fieldbus Coupler Modbus TCP; 4th generation

URL

Download

Installation Notes

Product family

WAGO I/O System 750/753

[Show all products from the family](#)

Subject to changes. Please also observe the further product documentation!

WAGO GmbH & Co. KG

Hansastr. 27

32423 Minden

Phone: +49571 887-0 | Fax: +49571 887-169

Email: info.de@wago.com | Web: www.wago.com

Do you have any questions about our products?

We are always happy to take your call at +49 (571) 887-44222.