

172165-1 ✓ ACTIVE

MATE-N-LOK | Mini-Universal MATE-N-LOK

TE Internal #: 172165-1

2 Position, Plug, Housing, Crimp, Wire-to-Wire, UL 94V-0, 4.2 mm [.165 in] Centerline, 1 Row, 600 VAC, Wire & Cable, Mini-Universal MATE-N-LOK

[View on TE.com >](#)



Connectors > Rectangular Connectors > Standard Rectangular Connectors



Connector Product Type: **Housing**

Connector & Housing Type: **Plug**

Termination Method to Wire & Cable: **Crimp**

Connector System: **Wire-to-Wire**

Contact Retention Within Housing: **Without**

Features

Product Type Features

Connector Product Type	Housing
Connector & Housing Type	Plug
Connector System	Wire-to-Wire
Sealable	No
Connector & Contact Terminates To	Wire & Cable

Configuration Features

Number of Positions	2
Number of Rows	1
Number of Power Positions	0
Number of Signal Positions	0

Electrical Characteristics

Operating Voltage	600 VDC
-------------------	---------

Body Features

Primary Product Color	Natural
-----------------------	---------

Contact Features

Multiple Contact Types	Without
Contact Layout	Inline
Contact Retention Within Housing	Without
Contact Type	Socket

Termination Features

Termination Method to Wire & Cable	Crimp
------------------------------------	-------

Mechanical Attachment

Panel Mount Feature	Without
Connector Mounting Type	Cable Mount (Free-Hanging)

Housing Features

Centerline (Pitch)	4.2 mm [.165 in]
Housing Material	Nylon 66

Usage Conditions

Operating Temperature Range	-20 – 105 °C [-4 – 221 °F]
-----------------------------	----------------------------

Operation/Application

Circuit Application	Power & Signal
---------------------	----------------

Industry Standards

Compatible With Agency/Standards Products	CSA, UL
UL Rating	Recognized
Compatible With Approved Standards Products	UL E28476
CSA Rating	Certified, LR 7189
UL Flammability Rating	UL 94V-0
Glow Wire Rating	Standard Part - Not Glow Wire

Packaging Features

Packaging Quantity	1000
Packaging Method	Bag

Product Compliance

[For compliance documentation, visit the product page on TE.com>](#)

EU RoHS Directive 2011/65/EU	Compliant
------------------------------	-----------



EU ELV Directive 2000/53/EC

Compliant

China RoHS 2 Directive MIIT Order No 32, 2016

有害物质含量符合标准要求 No Restricted Substance(s) Above Threshold

EU REACH Regulation (EC) No. 1907/2006

Current ECHA Candidate List: JUNE 2025 (250)
Candidate List Declared Against: JUNE 2025 (250)
Does not contain REACH SVHC

Halogen Content

Low Halogen - Br, Cl, F < 900 ppm per homogenous material. Also BFR/CFR/PVC Free

Solder Process Capability

Not applicable for solder process capability

Product Compliance Disclaimer

This information is provided based on reasonable inquiry of our suppliers and represents our current actual knowledge based on the information they provided. This information is subject to change. The part numbers that TE has identified as EU RoHS compliant have a maximum concentration of 0.1% by weight in homogenous materials for lead, hexavalent chromium, mercury, PBB, PBDE, DBP, BBP, DEHP, DIBP, and 0.01% for cadmium, or qualify for an exemption to these limits as defined in the Annexes of Directive 2011/65/EU (RoHS2). Finished electrical and electronic equipment products will be CE marked as required by Directive 2011/65/EU. Components may not be CE marked. Additionally, the part numbers that TE has identified as EU ELV compliant have a maximum concentration of 0.1% by weight in homogenous materials for lead, hexavalent chromium, and mercury, and 0.01% for cadmium, or qualify for an exemption to these limits as defined in the Annexes of Directive 2000/53/EC (ELV). Regarding the REACH Regulation, the information TE provides on SVHC in articles for this part number is based on the latest European Chemicals Agency (ECHA) 'Guidance on requirements for substances in articles' posted at this URL: <https://echa.europa.eu/guidance-documents/guidance-on-reach>

Compatible Parts





Also in the Series | **Mini-Universal MATE-N-LOK**

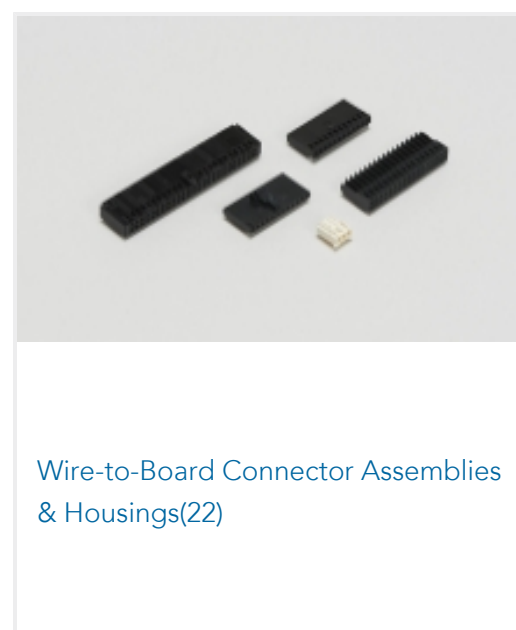
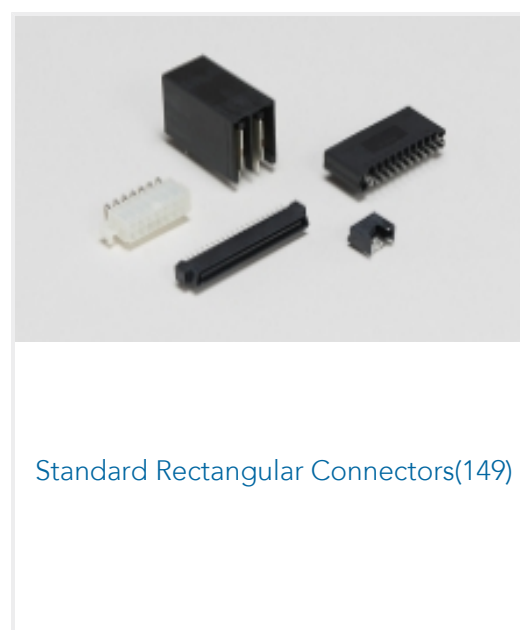
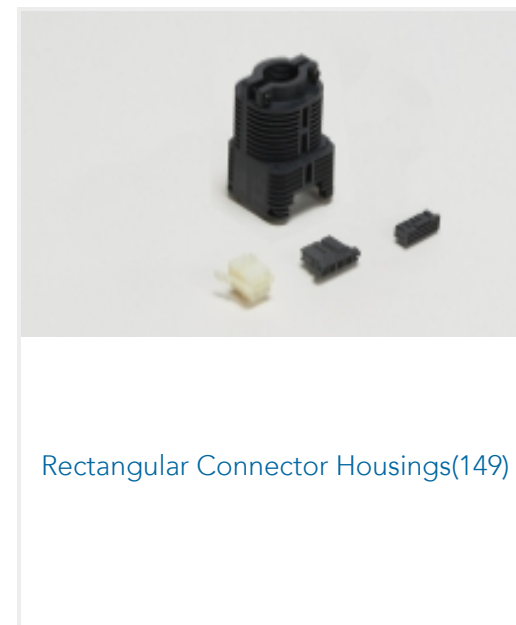
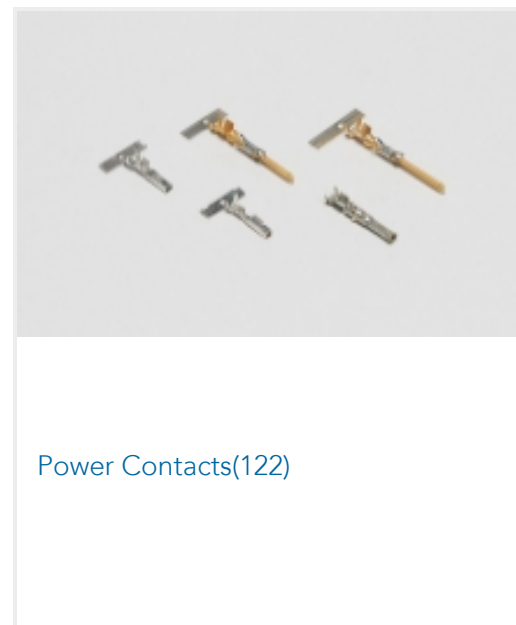
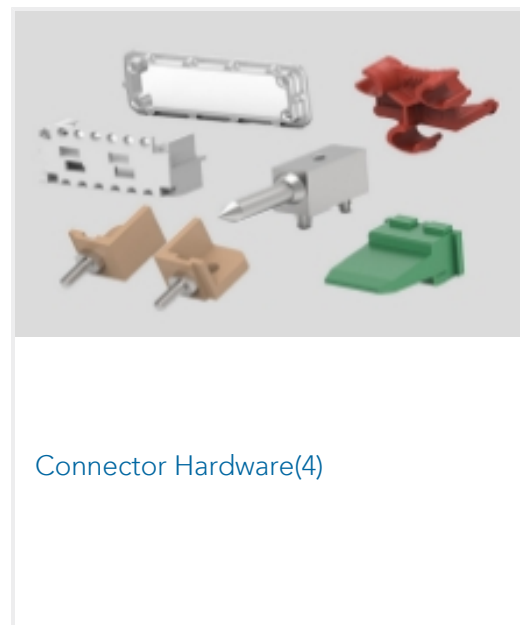
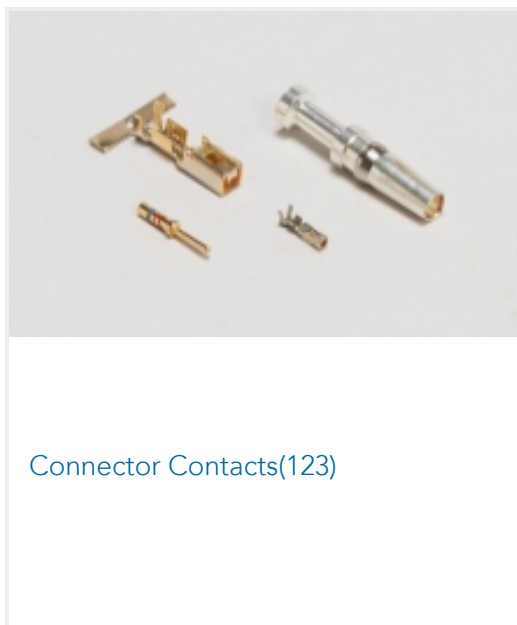

Customers Also Bought

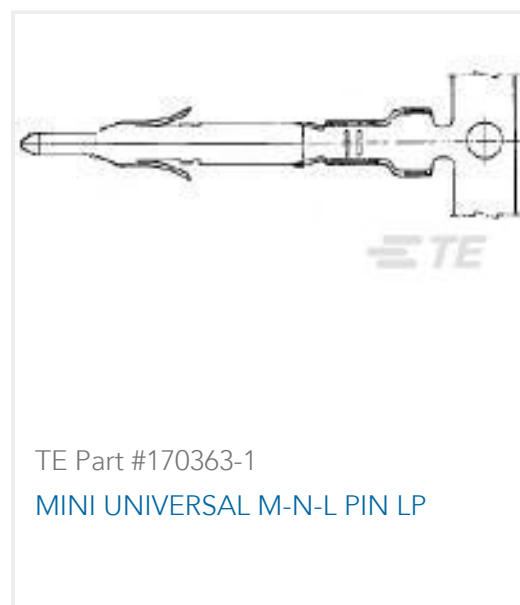



Documents

Product Drawings

[2 CIR UNIV M-N-L PLUG NATL](#)

English

CAD Files

[3D PDF](#)

3D

Customer View Model

[ENG_CVM_CVM_172165-1_H.2d_dxf.zip](#)

English

Customer View Model

[ENG_CVM_CVM_172165-1_H.3d_igs.zip](#)

English

Customer View Model

[ENG_CVM_CVM_172165-1_H.3d_stp.zip](#)

English

By downloading the CAD file I accept and agree to the [Terms and Conditions](#) of use.

Datasheets & Catalog Pages

[SOFT_SHELL_PIN_AND_SOCKET_CONNECTORS_CATALOG](#)

English

[mini-universal-mate-n-lok-connectors](#)

English

Product Specifications

[Engineering Report](#)

English



Instruction Sheets

[Instruction Sheet \(U.S.\)](#)

English

Agency Approvals

[Agency Approval Document](#)

English